



Product Description

Durable clear anodized finish

Disc type design allows superior air flow control

Diamond knurl nozzle grip

1.63 inch inside diameter nozzle

Threaded plenum cap type installation

Plenum cap with 1.50 inch hose port

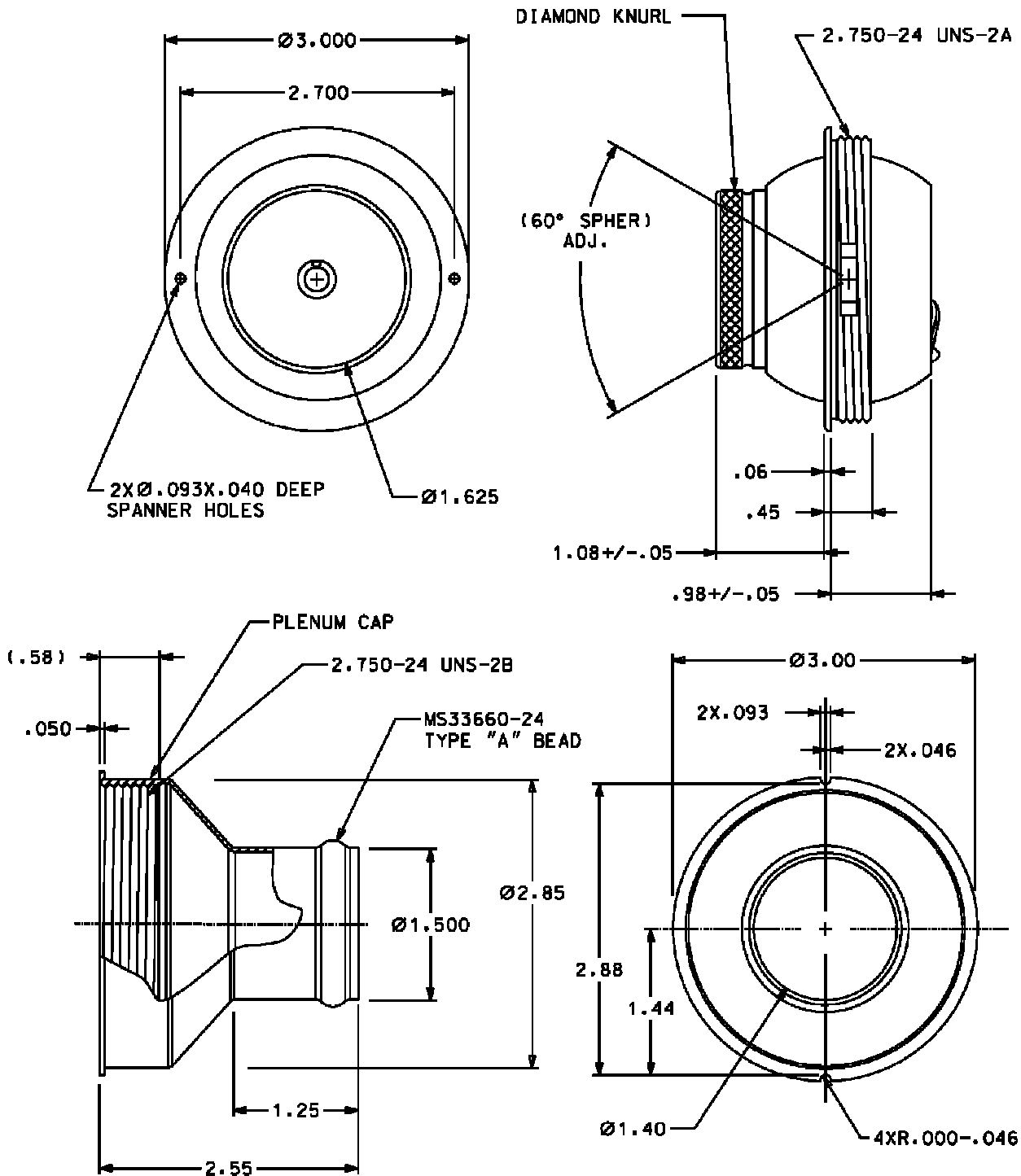

The disc type design, supplied with a clear or black anodized finish, allows for a larger air flow pattern and low air leakage. The air valve has a threaded plenum cap for ease of installation. The air valve is designed for single engine aircraft and rotorcraft.

14321 Commerce Drive
 Garden Grove CA, 92843
 Phone: 714-554-9782
 Fax: 714-554-3659
 www.birkaero.net