



Product Description

Poppet type design for low leakage

Injection molded black ball, nozzle, and poppet

Straight knurl nozzle grip

1.06 inch inside diameter nozzle

Small mounting envelope

Mounting nut type installation

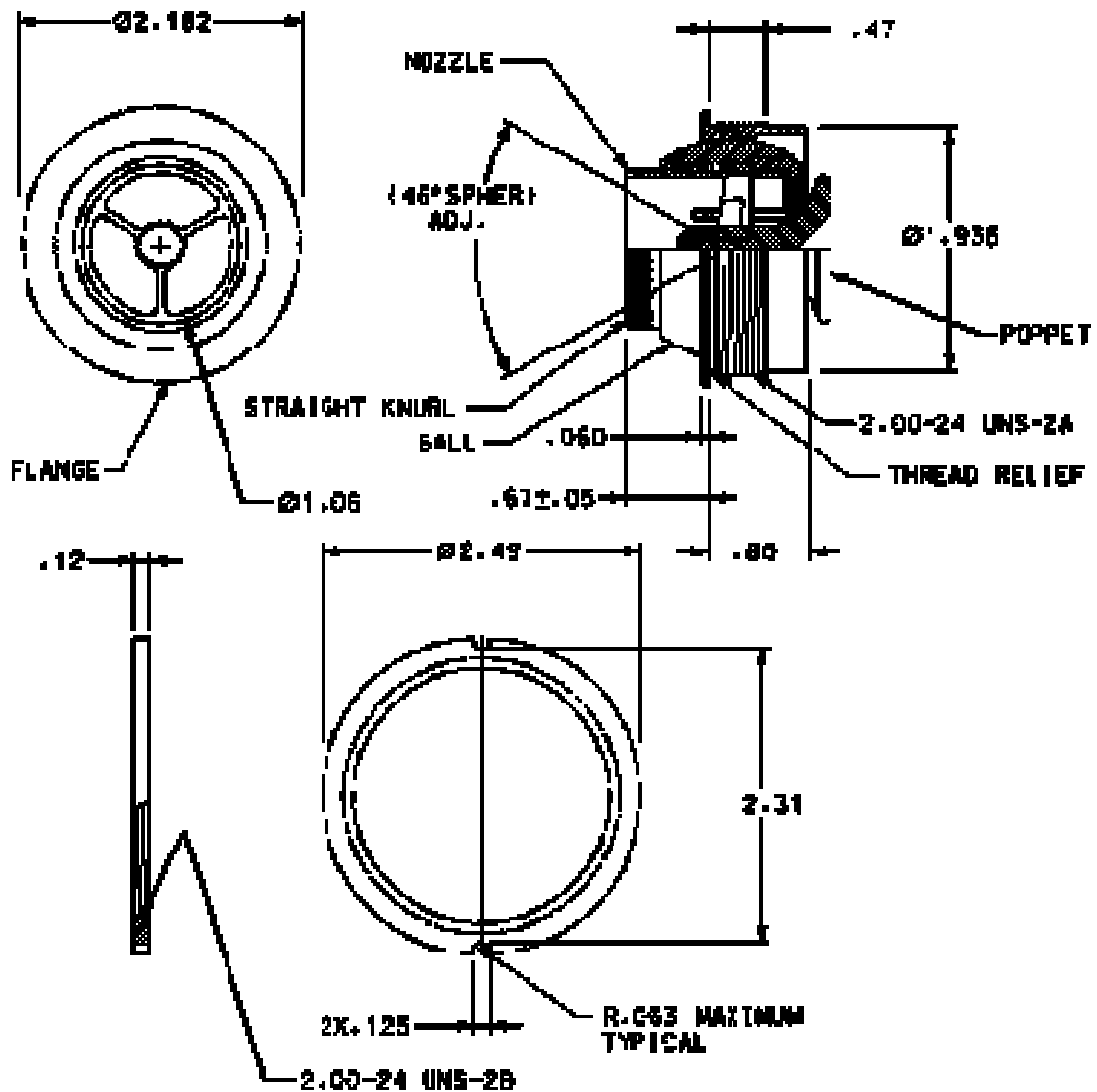

The AV4080 poppet type air valve is designed to provide high air flow volumes at low duct pressures and has minimal leakage in the closed position. The nozzle and ball are provided in black polycarbonate to reduce condensation and weight. The light weight low cost solution is well suited for single engine and light sport aircraft.

14321 Commerce Drive
Garden Grove CA, 92843

Phone: 714-554-9782
Fax: 714-554-3659
www.birkaero.net