

THE INFORMATION DISCLOSED HEREIN WAS ORIGINATED BY AND IS THE PROPERTY OF BIRK AEROSYSTEMS CORPORATION. BIRK AEROSYSTEMS CORPORATION RESERVES ALL PATENT, PROPRIETARY, DESIGN, USE, MANUFACTURING AND REPRODUCTION RIGHTS.

NOTE (S) :

1. LED COLOR: COOL WHITE
2. IDENTIFY WHERE SHOWN WITH THE FOLLOWING:
 - A) BAC
 - B) PART NUMBER
 - C) DATE CODE: YYWW
 - D) VOLTAGE : 28V
3. BEZEL FINISH:
 - 1: MATTE (SISAL) TEXTURE WITH CLEAR ANODIZE PER MIL-A-8625 TYPE II, CLASS I. NICKEL ACETATE SEAL.
 - 2: FINE SATIN TEXTURE WITH CLEAR ANODIZE PER MIL-A-8625 TYPE II, CLASS I. NICKEL ACETATE SEAL.
4. ACCEPTANCE TEST PER ATP13625.

REV STATUS OF SHEETS	REV	A	A
SHEET 1	2		

ZONE	REV	DESCRIPTION	DATE	APPROVED
	-	SEE DCN 4502.	10-08-04	BLB
	A	SEE DCN 5872.	12-06-20	BLB

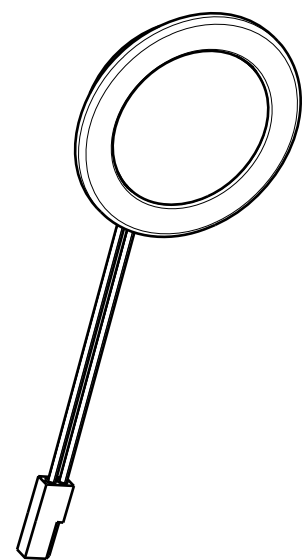

ISOMETRIC VIEW

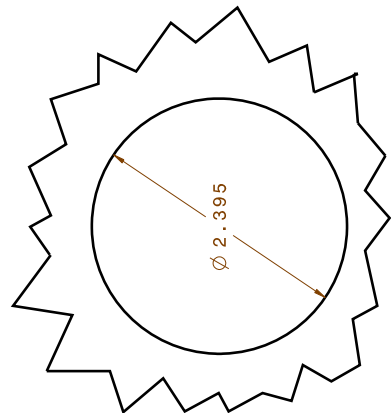

RECOMMENDED MOUNTING HOLE
MAXIMUM PANEL THICKNESS: 0.25

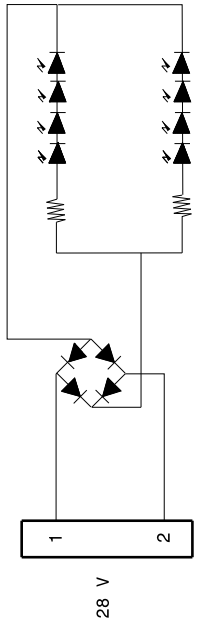

CIRCUIT DIAGRAM

V = 28 V
I_f = 69 mA
I_{max} = 79 mA

1

2

3

4

13625-2	CLOSET LIGHT, LED TYPE	POLYCARBONATE/AL ALLOY
1	1	1
MN8006-1	MOUNTING NUT	AL ALLOY
13625-1	CLOSET LIGHT, LED TYPE	POLYCARBONATE/AL ALLOY
2	2	2
1	1	1
2	2	2
1	1	1
2	2	2
1	1	1
2	2	2

QTY.	REQD.	CODE	IDENTIFYING NO.	DESCRIPTION	SPECIFICATION	ITEM NO.

CONTRACT NO. _____

APPROVALS	DATE	TITLE
DRAWN: SM	10-08-04	BIRK AEROSYSTEMS CORPORATION GARDEN GROVE, CALIFORNIA 92843
CHECKED: BLB	10-08-04	CLOSET LIGHT, LED TYPE
ENGR: BLB	10-08-04	
ISSUED: CLB	10-08-04	

FILE NO. CL13625/PV SCALE 1/1 INT. SHEET 1 OF 2

1

2

3

4

THE INFORMATION DISCLOSED HEREIN WAS ORIGINATED BY AND IS THE PROPERTY OF BIRK AEROSYSTEMS CORPORATION. BIRK AEROSYSTEMS CORPORATION RESERVES ALL PATENT, PROPRIETARY, DESIGN, USE, MANUFACTURING AND REPRODUCTION RIGHTS.

2 CIRCUIT MOLEX RECEPTACLE, 03-06-1023
MOLEX PIN, 02-06-2103

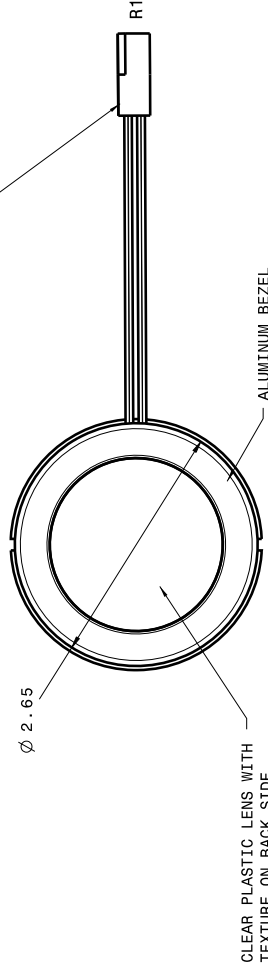

-1, -2

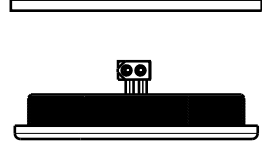
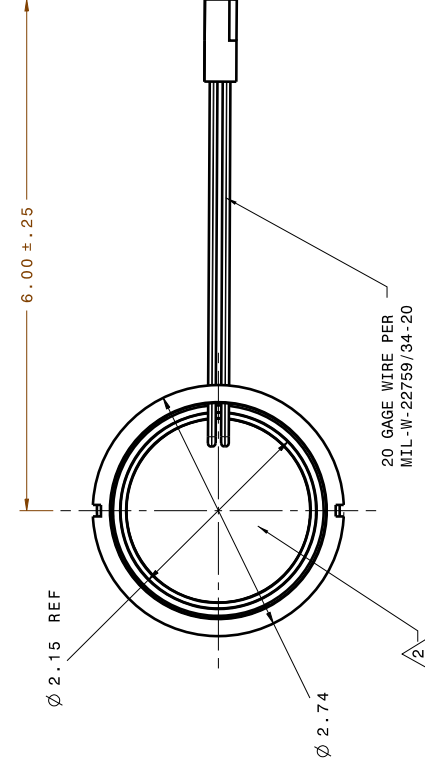
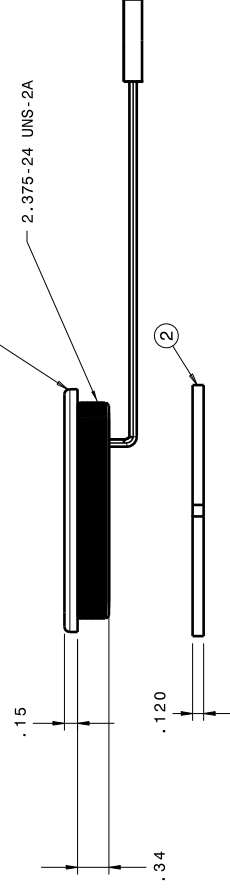

1

2

3

4

ZONE	REV	DESCRIPTION	DATE	APPROVED
	-	SEE DCN 4502.	10-08-04	BLB
	A	SEE DCN 5872.	12-06-20	BLB

DWG. NO.	CL13625	SH	2	REV	A
----------	---------	----	---	-----	---

CONTRACT NO.		APPROVALS		DATE	TITLE
		DRAWN	SM	10-08-04	BIRK AEROSYSTEMS CORPORATION GARDEN GROVE, CALIFORNIA 92843
UNLESS OTHERWISE SPECIFIED DIMENSIONS ARE IN INCHES		CHECKED	BLB	10-08-04	CLOSET LIGHT, LED TYPE
FRACTIONS	DECIMALS	ENGR	BLB	10-08-04	SCALE 1/1
-1/32	.XXX	ISSUED	CLB	10-08-04	FILE NO. CL13625/PV2
DO NOT SCALE DRAWING	SEE PL	SEE NOTE(S)		SIZE	CAGE CODE
MATERIAL				10-08-04	1XE65
FINISH				10-08-04	DWG. NO. CL13625
TREATMENT				10-08-04	REV. A
				10-08-04	SHEET 2

1

2

3

4